

LiFePO₄

NovaBase 200 Ah

Lithium-Eisenphosphat-Batterien (LiFePO₄)



SPEZIFIKATIONEN

Nennspannung	12,8 V
Nennkapazität	200 Ah / 2560 Wh
Innenwiderstand	≤ 20 mΩ
Effizienz	99 %
Selbstentladung	≤ 2,5 % / Monat
Max. Batterieanzahl in Reihenverschaltung	4
Max. Batterieanzahl in Parallelverschaltung	4
Zyklenlebensdauer	≥4000 bei 80 % DoD

ENTLADUNG

Max. Dauerentladestrom	250 A
Spitzenentladestrom	300 A (5 min.)
BMS-Entladeabschaltstrom	600 A ± 10 A (50 ~ 200 ms)
Empfohlene Last-Abschaltspannung	11.0 V
BMS Abschaltspannung (Entladung)	10.8 V
BMS Wiedereinschaltung (Entladung)	11.6 V
Kurzschlusschutz	200 ~500 μs

ZULÄSSIGE TEMPERATURBEREICHE

Entladung	-30 °C bis +60 °C
Ladung	0 °C bis +45 °C
Lagerung	-5 °C bis +35 °C
BMS Cut-Off-Temperatur	+65 °C

ALLGEMEINE INFORMATIONEN

Maße (L x W x H)	(485 x 170 x 240 mm) ± 2 mm
Gewicht	21.7 kg ± 0.1 kg
Empfohlener Nachladezeitpunkt (Lagerung)	Nach 6 Monaten
Material	ABS
Schutzklasse	IP 65
Zelltyp / Chemie	Prismatisch, LiFePO ₄
Anschluss	M8 Schraubgewinde
Produktgarantie	5 Jahre
Artikelnummer	502-55006

LADUNG

Empfohlener Ladestrom	100 A
Maximaler Ladestrom	200 A
Empfohlene Ladespannung	14.6 V
Float Ladespannung (Lagerung)	13.8 V
BMS Abschaltspannung (Ladung)	15.0 V
BMS Wiedereinschaltungsspannung (Ladung)	14.2 V

RICHTLINIEN

Zertifikate	CE, UN38.3, ECE R10.6 (Batterie) MSDS UL1642, IEC62133 (Zellen)
Versandklasse	UN 3480, class 9

Abmaße [mm]

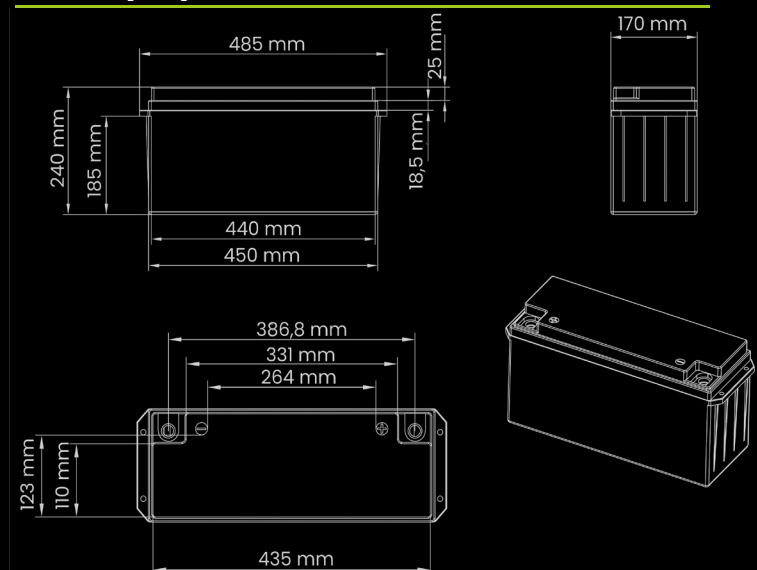

Technische Änderungen, Irrtümer und Druckfehler vorbehalten Stand 02.2024

LiFePO4



NovaBase 200 Ah

Lithium-Eisenphosphat-Batterien (LiFePO4)



VERSCHIEDENE ENTLADEGESCHWINDIGKEITEN (25 °C)

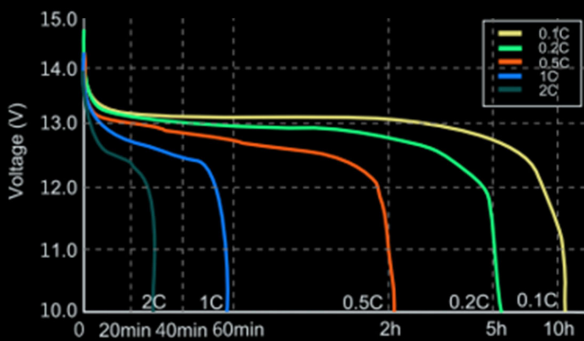

ENTLADEKURVE VERSCHIEDENE TEMPERATUREN (0.5 C)

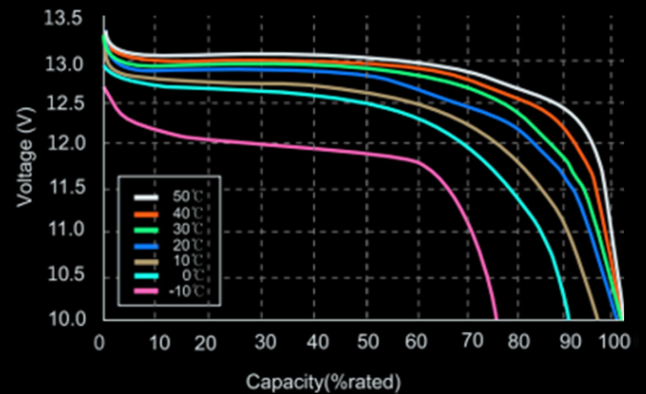

ZUSAMMENHANG LADEZUSTAND UND SPANNUNG (0.5C 25 °C)

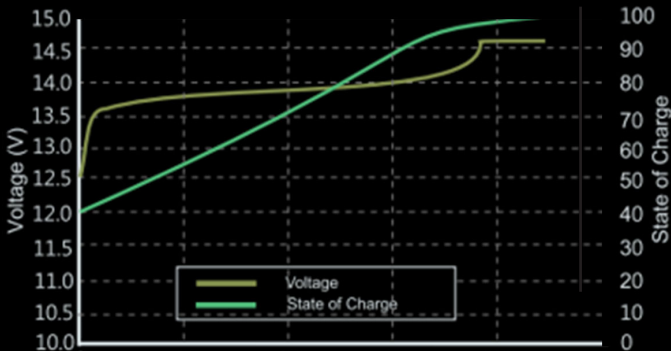

LADECHARAKTERISTIK (0.5C, 25 °C)

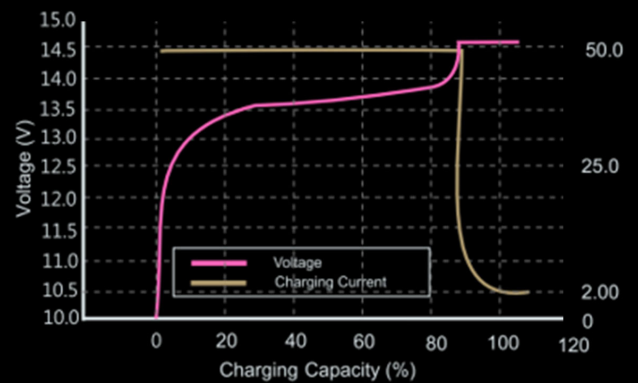

ZYKLENFESTIGKEIT IN RELATION ENTLADETIEFE

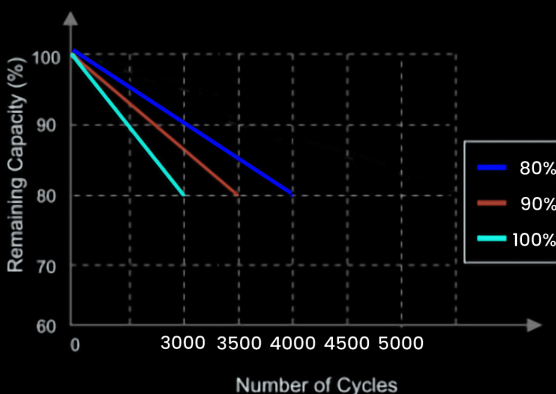

SELBSTENTLADUNG BEI VERSCHIEDENEN TEMPERATUREN

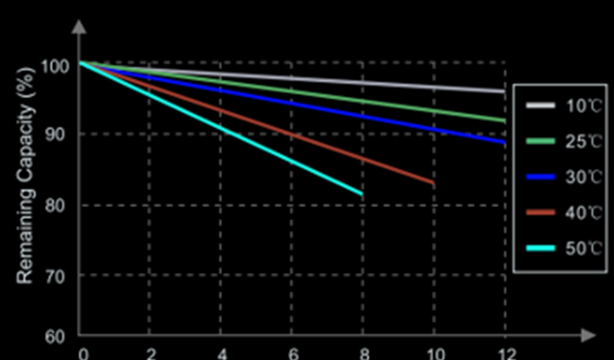

Technische Änderungen, Irrtümer und Druckfehler vorbehalten Stand 02.2024

LiFePO₄

NovaBase 200 Ah

Lithium iron phosphate battery (LiFePO₄)



GENERAL SPECIFICATIONS

Nominal Voltage	12,8 V
Nominal Capacity	200 Ah / 2560 Wh
Resistance	≤ 20 mΩ
Efficiency	99 %
Self Discharge	≤ 2.5 % / Month
Maximum Batteries in Series	4
Maximum Batteries in Parallel	4
Cycle Life	≥4000 bei 80 % DoD

DISCHARGE SPECIFICATIONS

Maximum Continuous Discharge Current	250 A
Peak Discharge Current	300 A (5 min.)
BMS Discharge Cut-Off Current	600 A ± 10 A (50 ~ 200 ms)
Recommended Low Voltage Disconnect	11.0 V
BMS Discharge Voltage Cut-Off	10.8 V
BMS Reconnect Voltage (Discharging)	11.6 V
Short Circuit Protection	200 ~500 μs

TEMPERATURE SPECIFICATIONS

Discharge Temperature	-30 °C bis +60 °C
Charge Temperature	0 °C bis +45 °C
Recommended Storage Temperature	-5 °C bis +35 °C
BMS Discharge Cut-Off Temperature	+65 °C

GENERAL INFORMATION

Dimensions (L x W x H)	(485 x 170 x 240 mm) ± 2 mm
Weight	21.7 kg ± 0.1 kg
Recommended recharging time (storage)	After 6 Month
Case Material	ABS
Enclosure Protection	IP 65
Cell Type - Chemistry	Prismatic, LiFePO ₄
Terminal	M8 Screw thread
Product guarantee	5 Years
Product Code	502-55006

CHARGE SPECIFICATIONS

Recommended Charge Current	100 A
Maximum Charge Current	200 A
Recommended Charge Voltage	14.6 V
Float Charge Voltage (Standby use)	13.8 V
BMS Charge Voltage Cut-Off	15.0 V
BMS Reconnect Voltage (Charging)	14.2 V

GUIDELINES

Certifications	CE, UN38.3, ECE R10.6 (Battery) MSDS UL1642, IEC62133 (Cells)
Shipping Classification	UN 3480, class 9

DIMENSIONAL SPECIFICATIONS [mm]

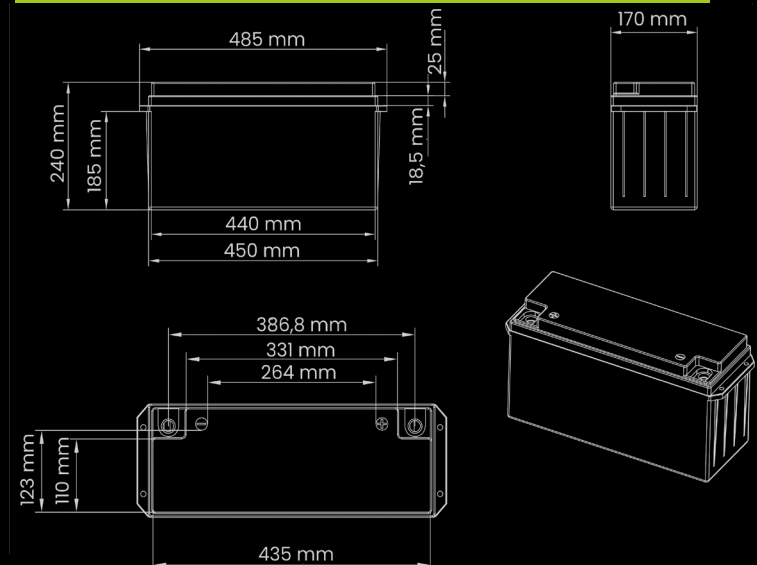

Technical changes, errors and misprints reserved Stand 02.2024

LiFePO4



NovaBase 200 Ah

Lithium iron phosphate battery (LiFePO4)



DIFFERENT RATE DISCHARGE CURVE (25 °C)

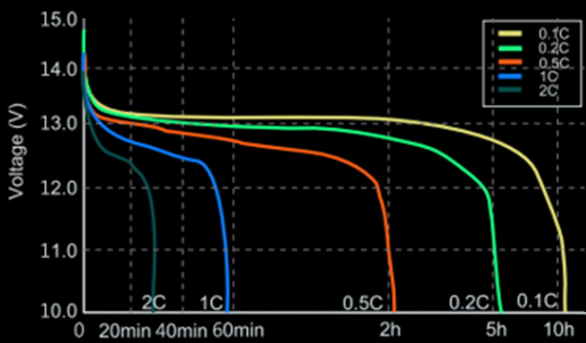

DIFFERENT TEMPERATURE DISCHARGE CURVE (0.5 C)

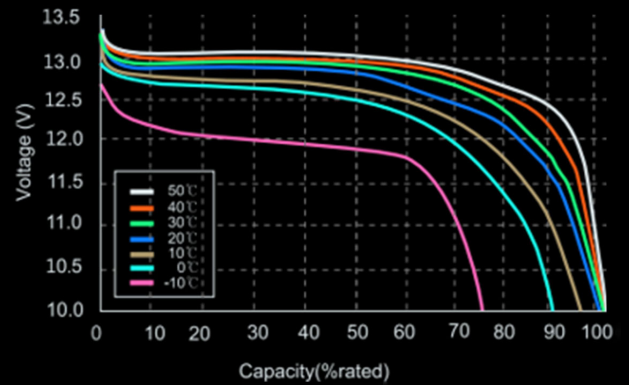

STATE OF CHARGE CURVE (0.5C 25 °C)

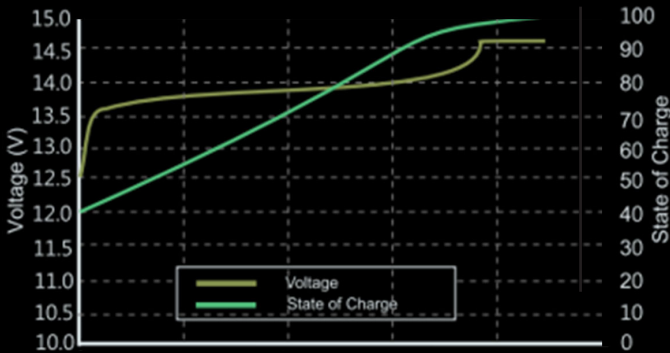

CHARGING CHARACTERISTICS (0.5C, 25 °C)

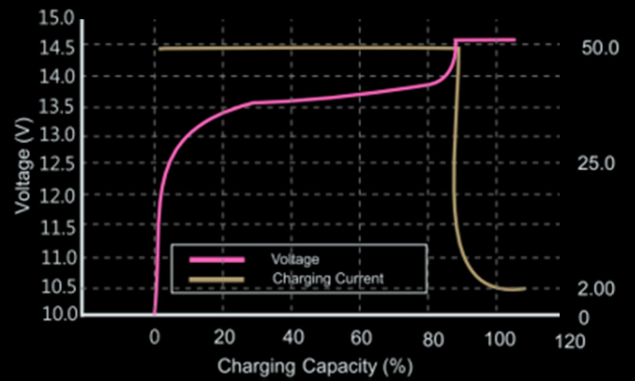

CYCLE LIFE IN RELATION TO DEPTH OF DISCHARGE

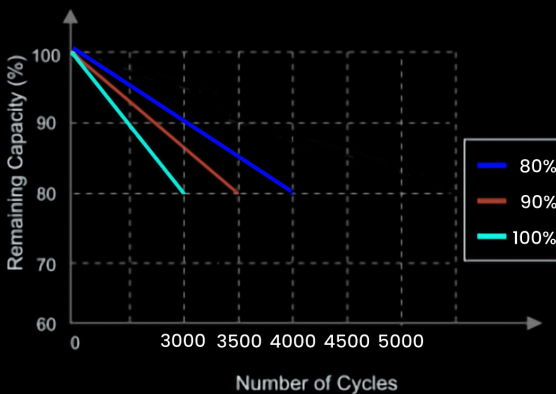

DIFFERENT TEMPERATURE SELF DISCHARGE CURVE

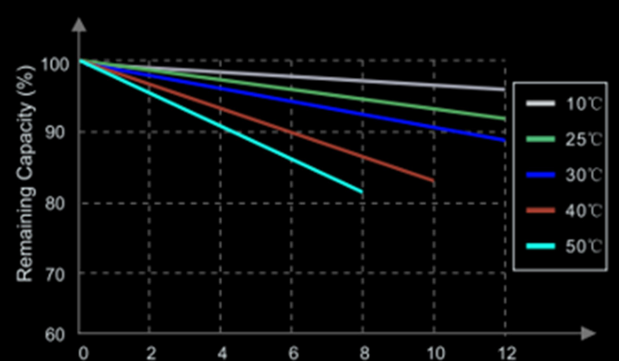

Technical changes, errors and misprints reserved Stand 02.2024